

Telex

Operating Instructions

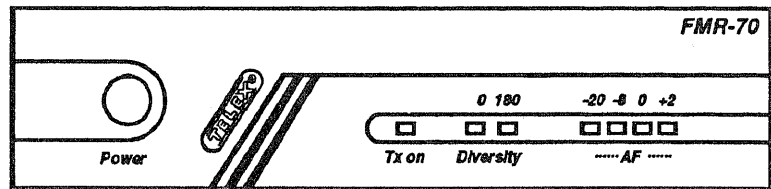
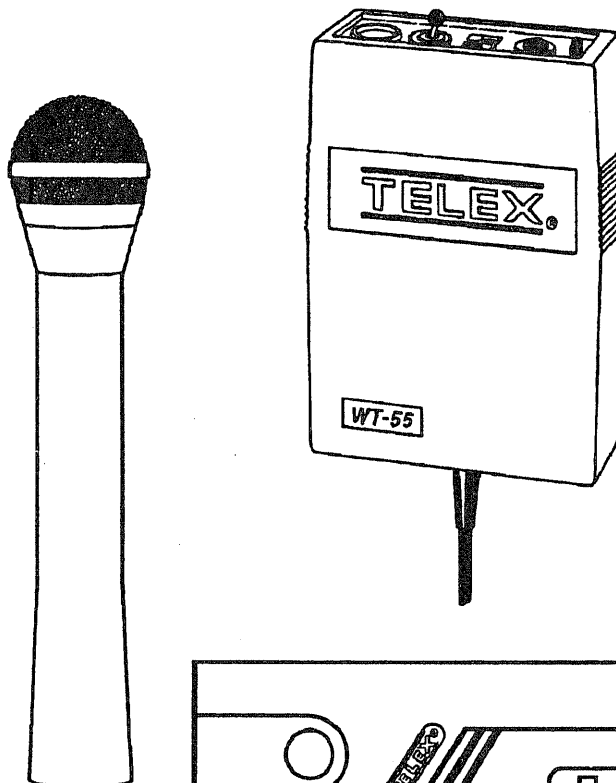

Professional Wireless Microphone System

FMR-70

WT-55

HT-200

TELEX®

Table of Contents

	Page
INTRODUCTION	1
WHAT IS A WIRELESS MICROPHONE?	1
MICROPHONE	1
TRANSMITTER	1
RECEIVER	1
WHAT FREQUENCY BAND DOES THE TELEX SYSTEM OPERATE IN?	1
OFTEN ASKED QUESTIONS	2
FMR-70 RECEIVER	3
TECHNICAL INFORMATION	3
SPECIFICATIONS	3
FEATURES	3
CONTROLS AND CONNECTIONS	4
FRONT PANEL	4
REAR PANEL	5
WT-55 WIRELESS BELT TRANSMITTER	6
TECHNICAL INFORMATION	6
SPECIFICATIONS	6
FEATURES	6
CONTROLS AND CONNECTIONS	7
TOP OF UNIT	7
REAR OF UNIT	8
HT-200 WIRELESS MICROPHONE	9
TECHNICAL INFORMATION	9
TRANSMITTER SPECIFICATIONS	9
MICROPHONE SPECIFICATIONS	9
FEATURES	9
CONTROLS AND CONNECTIONS	10
EQUIPMENT SET-UP	11
UNPACKING	11
TRANSMITTER BATTERY INSTALLATION	11
BATTERY INFORMATION	11
WT-55	11
ALL HT-100 SERIES MODELS	12
TRANSMITTER BATTERY CHECK	12
WT-55	12
HT-200	12
TRANSMITTER MICROPHONE	13
WT-55	13
HT-200	13

Table of Contents (Cont.)

COMPANDOR IN/OUT	13
WT-55	13
HT-200	13
FMR-70 POWER CONNECTION	14
ANTENNA INFORMATION	14
FMR-70 ANTENNA CONNECTION	14
WT-55 ANTENNA PLACEMENT	15
HT-200 ANTENNA	15
SYSTEM CONFIGURATION	15
INCREASING/IMPROVING RECEPTION AND RANGE	16
RECEIVER CONNECTION TO SOUND SYSTEM	18
SYSTEM TURN ON	18
INTRODUCTION	18
FMR-70 RECEIVER	18
WT-55 BELT TRANSMITTER	19
HT-200 MICROPHONE	19
SETTING SYSTEM GAIN LEVELS	19
WT-55 AND HT-200 SOUND PRESSURE LEVEL (SPL)	19
RECEIVER AUDIO ADJUST	21
SYSTEM WALK-THRU	22
GENERAL	22
CARRIER INDICATION	22
AUDIO FEEDBACK	22
TROUBLESHOOTING	23
BATTERY INFORMATION	24
GENERAL	24
ALKALINE BATTERIES	24
NICKEL-CADMIUM BATTERIES	24
MICROPHONE WIRING CHART	25
ACCESSORIES	26
WARRANTY SERVICE INFORMATION	28
FCC REGULATIONS	29

INTRODUCTION

WHAT IS A WIRELESS MICROPHONE?

MICROPHONE

This is an electro-acoustic transducer which responds to sound waves and delivers essentially equivalent electrical waves. These electrical waves are sent to the belt transmitter or hand-held unit.

TRANSMITTER

The transmitter generates and amplifies an RF (Radio Frequency) carrier signal, modulates this carrier with the microphone signal, and radiates the modulated RF carrier.

RECEIVER

The FM VHF receiver is tuned to the frequency of the transmitter. The receiver picks up the radiated RF signal from the transmitter through the antenna and converts the RF signal into audio voltages for use with PA, Line, Network, etc. The receiver frequency must be matched to the transmitter frequency.

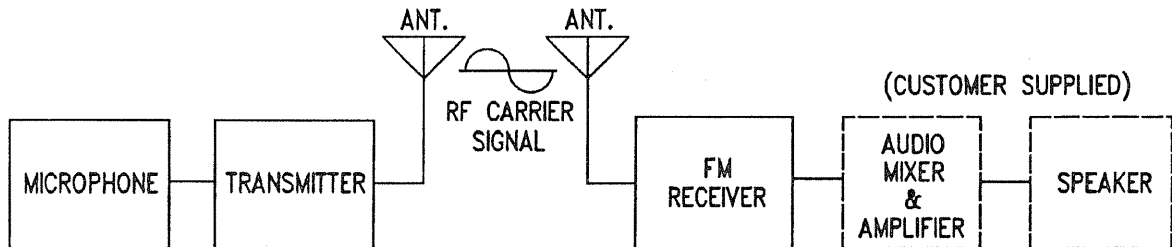

Figure 1
Block Diagram of Typical Wireless Microphone System

WHAT FREQUENCY BAND DOES THE TELEX SYSTEM OPERATE IN?

The Telex systems feature single channel, crystal controlled transmitters and receivers operating in the VHF Band between 150-216 MHz. The FMR-70 operates on specific standard frequencies within the range of 150 to 216 MHz, and is specifically designed to complement the Telex Model WT-55 transmitter or the HT-200 series handheld transmitter.

The FMR-70 is also fully compatible with all Telex Wireless Transmitters manufactured to date. The system operates on a fixed frequency which can be computer selected to provide "interference-free" operation. Over a dozen systems can be operated in a single location simultaneously.

OFTEN ASKED QUESTIONS

Questions: Can more than one wireless system be used simultaneously?

Answer: Yes, Over a dozen systems can be operated in a single location simultaneously, however, for every transmitter there must be a receiver on the same frequency. Each additional receiver/transmitter system must be on a different frequency.

Question: Is the system more sensitive in any one particular direction?

Answer: No, the transmitter antenna radiates equally in all directions, but the signal is attenuated by your body, walls or other surrounding objects. The receiving antenna is essentially sensitive in all directions as well, except when using a directional antenna.

Question: When the transmitter is turned off can the receiver pick-up other transmissions?

Answer: Yes it can. The Telex FMR-70 System operates in the VHF Band between 150-216 MHz. However, it is not susceptible to radio wave skip, CB'ers or FM Radio transmissions. The frequency your system operates on has been computer selected for least interference, but there is no such thing as a 100% clear channel all the time, anywhere in the U.S.A., forever!

If the system is going to be used in a permanent fixed location, the system should operate interference free until such a time or date when someone else begins using the same frequency.

If the system is going to be moving among various locations, you will inevitably run into occasional frequency conflicts.

In either case, when you're not using the wireless microphone, turn the gain down on your audio mixer, just as you would a wired microphone. If mixer control is not available, turn the receiver off when the transmitter is not in use. This will prevent the reception of undesired signals. If no mixer control is available and the system must be left on, the transmitter should be left on to prevent the receiver from picking up outside interference.

Question: Is Feedback a problem?

Answer: As with all microphones used in PA applications, feedback is a problem. To minimize feedback, the mixer or control operator should use the minimum level to produce the desired audio. If the system then appears to be overly sensitive, reduce the "Microphone Gain" on the back of the transmitter with a small plastic screwdriver (One is supplied with your transmitter) until you obtain the minimum level necessary. NOTE: Using a metal screwdriver may detune your units frequency. This is the best way of adjusting "Microphone Gain." Use the minimum gain necessary. Professional equalization of the sound system may be needed.

FMR-70 RECEIVER

TECHNICAL INFORMATION

SPECIFICATIONS

RF Frequency Range	150-216 MHz
Frequency Response	50-15,000 Hz +/-2 dB
RF Sensitivity	Less than 0.5 microvolt, 12 db SINAD
IF Selectivity	7 pole linear phase filter
Squelch Quieting	90 dB
Squelch Level	1 microvolt, internal
Antenna Input Impedance	50 ohms nominal
Image Rejection	Better than 75 dB
Audio Outputs	Mic: 200 ohms, -10 dBm max. Mic level adj. (Vol) -60 dBm min.
Signal-to-Noise Ratio	104 dB, typical
Temperature Range	32 degrees F to 122 degrees F (0 degrees C to 50 degrees C)
Input Power	13.0 VAC RMS with supplied adaptor or 12 to 14 VDC
Size	Approximately 7 1/2" W x 8" D x 1 3/4" H

FEATURES

The Telex Model FMR-70 is a receiver designed for use wherever compact size with commercial features is required. Features include:

- Powered by an external AC supply, or via the power jack on the rear of the FMR-70 with any 13 VAC RMS/ 12-14VDC source.
- The FMR-70 Receiver has been especially designed to provide the user with a system free from clicks, thumps and noise spikes commonly found in more economical systems.
- True diversity.
- 0 and 180 degree lights to show diversity operation.
- An all metal case for superior shielding.
- High performance RF front end that includes a GaAsFet RF amplifier for superior rejection and overload capability.
- Tx on indicator to aid in installation or monitoring.
- True noise type squelch.
- Linear phase filters for high quality low distortion audio response.
- XLR type AF output connector.
- AF output level adjustment control.
- An AF bar graph indicator to aid in installation/set up or monitoring audio output.
- Molded type front panel for aesthetic appeal and function.

27156-B-004-A

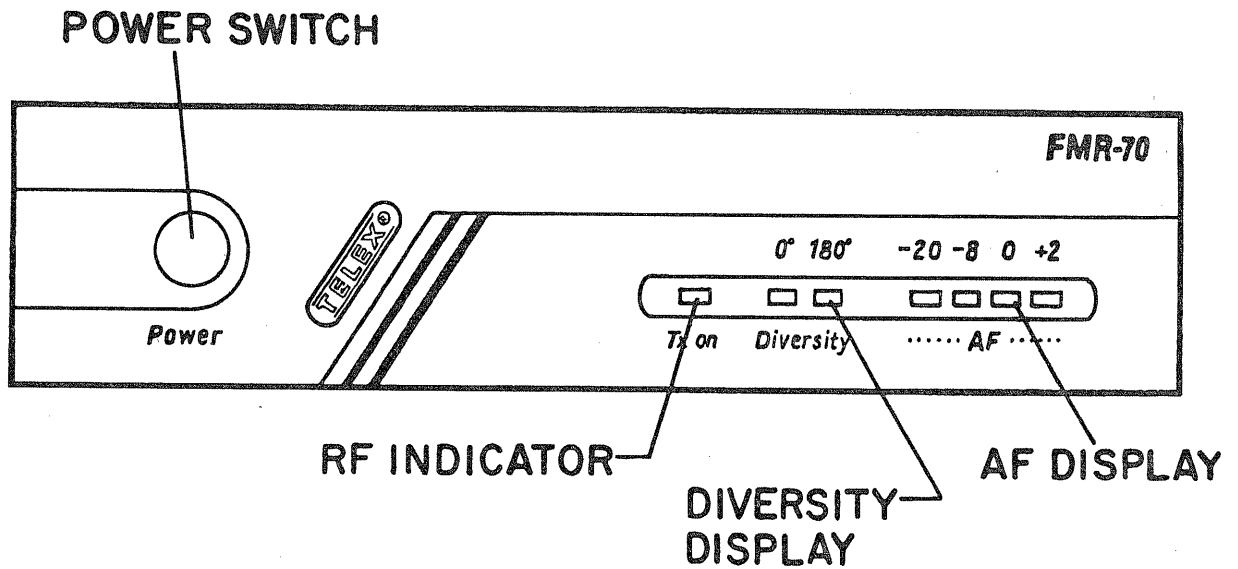

Figure 2
Front View FMR-70

FRONT PANEL

Power Switch: Push this switch once to turn ON; push it again to turn the power OFF.

RF Indicator: A carrier LED indicates the FMR-70 receiving the transmitted signal.

Diversity Display: A 2-segment LED Bar indicates 0 or 180 degree diversity.

AF Display: A 4-segment two-color LED Bar indicates the relative modulation of the system.

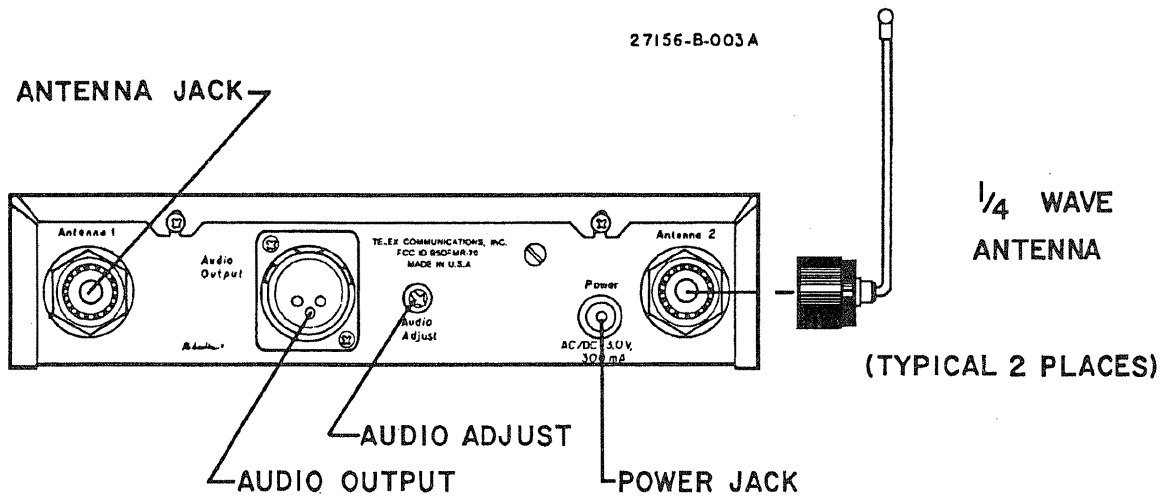

Figure 3
Rear View FMR-70

REAR PANEL

Antenna Jacks: Two antenna jacks for true diversity. Attach 1/4-wave antenna to each jack.

Audio Output: XLR connector, outputs to Audio Sound System (Amplifier/Mixer). Output is adjustable via the Audio Adjust potentiometer.

NOTE: USE CAUTION WHEN OPERATING WITH PHANTOM POWER SYSTEMS. THE SOURCE IMPEDANCE SHOULD BE AT LEAST 15K. OHMS TO PREVENT DAMAGE TO THE FMR-70 RECEIVER.

Audio Adjust: Screwdriver adjustable potentiometer, controls audio output. Use supplied plastic screwdriver to adjust to desired level.

Power Jack: For external AC wall supply adaptor (supplied). May use any filtered 12 to 14 VDC/100 mA Source, or 13.0 VAC RMS/100 mA Source.

WT-55 WIRELESS BELT TRANSMITTER

TECHNICAL INFORMATION

SPECIFICATIONS: WT-55

RF Frequency Range	150 to 216 MHz
RF Power Output	50 mW maximum 45 mW typical
RF Frequency Stability	0.005% crystal controlled
Modulation	FM, 12 KHz Deviation
Pre-Emphasis	50 μ Sec
AF Frequency Response	50 to 15000 Hz
Microphone Input	Low impedance, 100-10K ohm Dynamic or Electret
Current Drain	35 to 40 mA typical
FCC	Type accepted under FCC Part 90 and 74.

FEATURES

A belt-worn, battery powered, VHF FM transmitter which is ideally suited for any activity requiring a cordless portable microphone. Features include:

- The unit is compact, lightweight, and self-contained.
- Low battery test and indicator.

- Screwdriver adjustable Microphone Gain Control, as well as a simple Hi/Lo Switch.
- Uses standard 9 volt battery.
- Microphone ON/OFF Switch to mute microphone.

CONTROLS AND CONNECTIONS

TOP OF UNIT

Power ON Switch: A low profile slide switch is provided to allow access to power ON but is clearly distinguishable from other controls to prevent accidentally turning off the power.

Battery Test Button/Battery Indicator: A push type switch allows the user to test the battery in circuit. A red LED near the switch will fail to light if a battery is weak or dead. Sufficient time is built into the indicator to pre-warn the user of an impending battery failure if the battery is tested periodically during use. The LED fails to light at 7.25 volts; at that time an average of 1 hour is left on the battery.

Gain Hi/Lo Switch: This switch allows the user to select a "High Gain" for low output microphones or instruments or a "Low Gain" for high output microphones or guitars. Additional audio level adjustment is available via the gain potentiometer accessible through a small hole in the back of the transmitter case.

Microphone ON/OFF: A ball tipped toggle switch is provided to allow the user to "MUTE" the microphone if desired. This switch does not turn off the transmitter RF and provides "popless" operation. Again, this switch is clearly distinguishable from other controls for ease of operation.

Microphone Jack: The WT-55 is designed to easily interface with dynamic or electret microphones in the 100-10k ohm impedance range. The microphone connector is permanently wired to provide a power source for electret microphones. See Figure 4 for microphone connections.

TRANSMITTER CONNECTOR

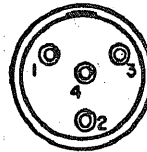

- 27156A-021-A
- 1-GROUND (SHIELD)
 - 2-AUDIO (MIC INPUT)
 - 3- +5V (3 WIRE MIC BIAS)
 - 4- +V (2 WIRE MIC BIAS)
(FOR 2 WIRE MIC, STRAP
2 TO 4 IN MIC PLUG)

NOTE: TELEX 2 WIRE MICROPHONE
HAVE 2 TO 4 STRAPPED AT FACTORY.

Figure 4
Microphone Connections

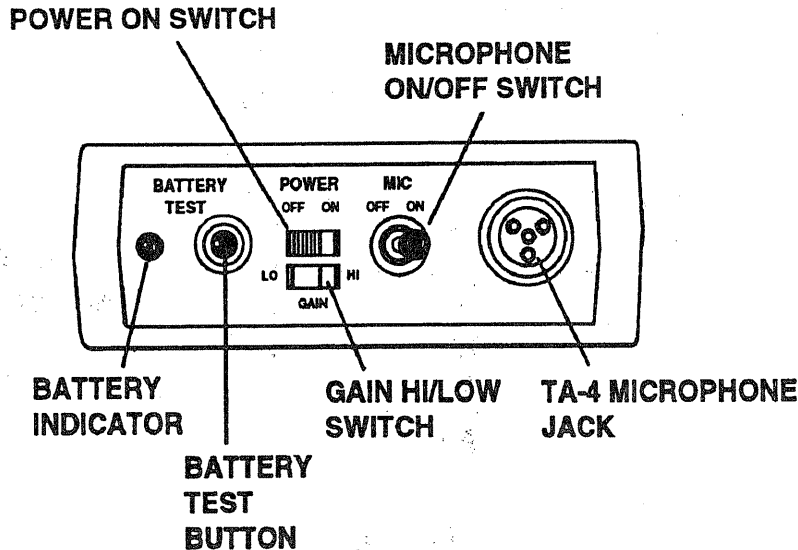

REAR OF UNIT

Trailing Wire Antenna: The WT-55 features a fully flexible 1/4-wave antenna. The antenna also has a permanent strain relief.

Microphone Gain Control: A screwdriver adjustable control which adjusts the Audio Gain of the microphone either up or down for different voice levels. A gain adjustment screwdriver is provided.

Belt Clip: The belt clip is supplied and is attached to the case.

Battery Compartment: Pull downward to expose battery compartment and battery connection terminal. Accepts either an alkaline or nickel-cadmium 9 volt transistor battery.

Battery Requirement: For maximum uninterrupted service, TELEX recommends that a new 9 volt alkaline battery (Mallory MN 1604 or equivalent) be installed prior to use. TELEX also offers a heavy duty nickel-cadmium, 8.4 volt rechargeable battery. Part Number 63912-000.

Average life on an alkaline battery is 6-8 hours and 1 1/2 to 2 hours per charge on a nickel-cadmium battery.

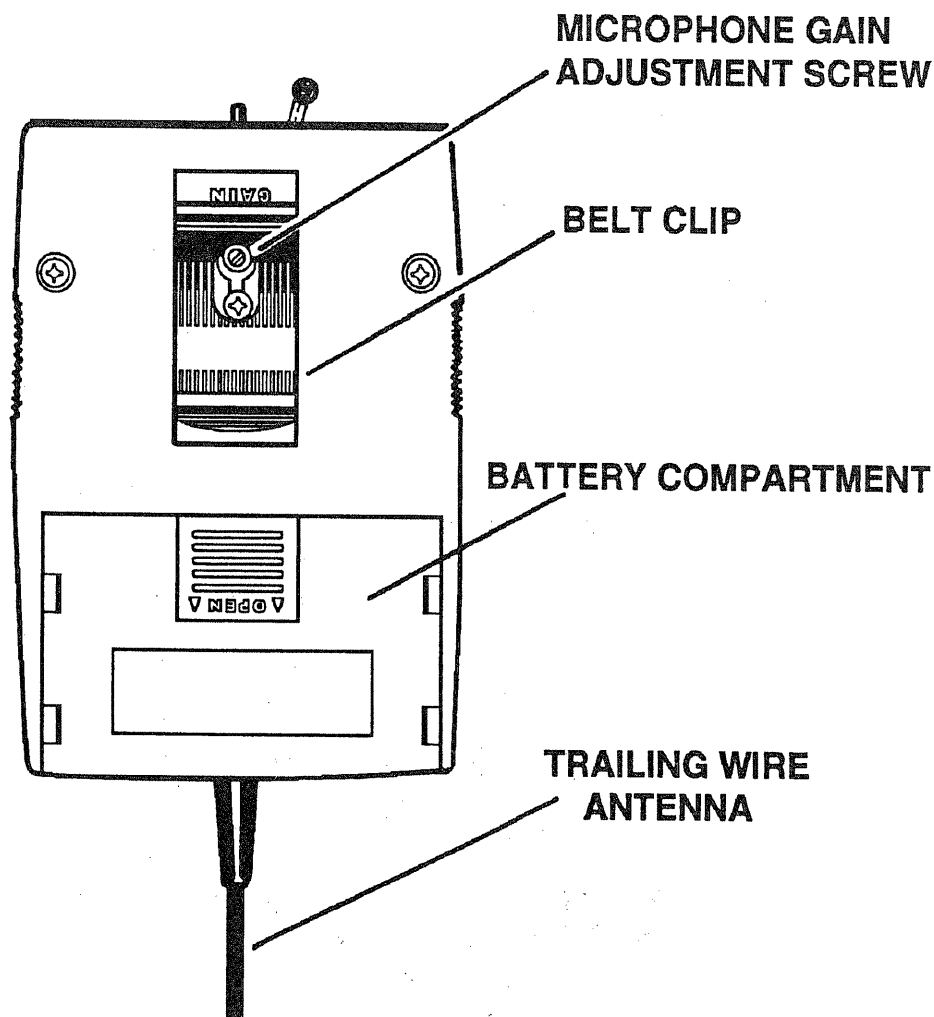

Figure 6
Back View WT-55

HT-200 WIRELESS MICROPHONE

TECHNICAL INFORMATION

GENERAL DESCRIPTION:

The HT-200 Series is a very versatile microphone which expands your selection to four popular microphone models. Its heavy-duty construction provides lightweight durability and its compact design assures reliability in the field.

FEATURES:

- Independent Power and Audio Switches
- Low Battery Indicator
- Screwdriver adjustable Gain Control
- Uses Standard 9 Volt Battery

TRANSMITTER SPECIFICATIONS:

Battery	9 Volt alkaline (NEDA 1604 or equivalent or 8.4 Volt NICAD Type)
Battery Life	10-12 hours typical on alkaline 2 to 3 hours typical on MICAD on one charge
Current Drain	35 mA
Modulation Limiter	Internal Compressor
Antenna	Integral to unit, omnidirectional
RF Power Output	45 mW typical
Range	1000 ft. (300 m) - Open field conditions, typical 250 ft. (76 m) - Adverse conditions, typical
Audio	+/- 1 dB, 50-15000 Hz (without head)
Radiated Harmonic and Spurious Emission Minimum	30 dB below Carrier
Modulation	+/- 12 KHz Deviaton, 50 uS pre-emphasis
FCC	Type accepted under Parts 90 and 74
Frequency Range	169-216 MHz

Microphone Specifications

HT-200/TE-10	Telex TE-10
Element Type	Condenser
Directional Pattern	Cardioid
Frequency Response	85-15000 Hz
Maximum SPL	140 dB
HT-200/SM-87	Sure SM-87
Element Type	Condenser
Directional Pattern	Super Cardioid
Frequency Response	85-15000 Hz
Maximum SPL	140 dB
HT-200/EV-757	Electro-Voice N/D757
Directional Pattern	Super Cardioid
Frequency Response	50-18000 Hz
Maximum SPL	144 dB
HT-200/SM-58	Shure SM-58
Element Type	Dynamic
Directional Pattern	Cardioid
Frequency Response	50-15000 Hz
Maximum SPL	140 dB

CONTROLS AND CONNECTIONS

Low Battery Indicator: Located at the bottom of the microphone. The red LED will flash briefly when the microphone is first turned on (with a fresh battery). when the LED stays on, the user has approximately one hour of remaining battery life.

Audio Switch: Located at the bottom of the microphone. The Audio Switch allows the user to switch the audio ON or OFF without introducing a "thump" into the sound system. A high profile slide switch is provided for easy identification.

Audio Gain Control: Accessed thru a hole at the bottom of the handle. A screwdriver is provided.

Power OFF/ON Switch: Located at the bottom of the microphone. A low profile slide switch is provided to allow access to power OFF/ON.

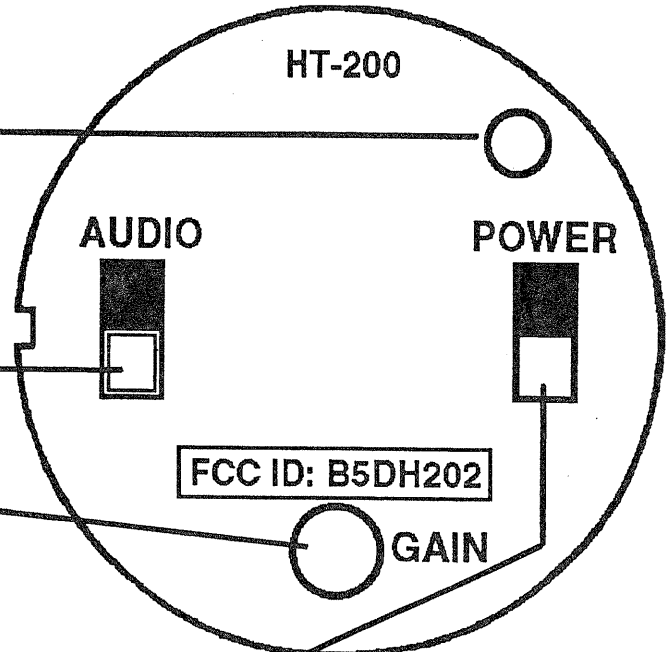

Figure 7A
Bottom View - HT-200

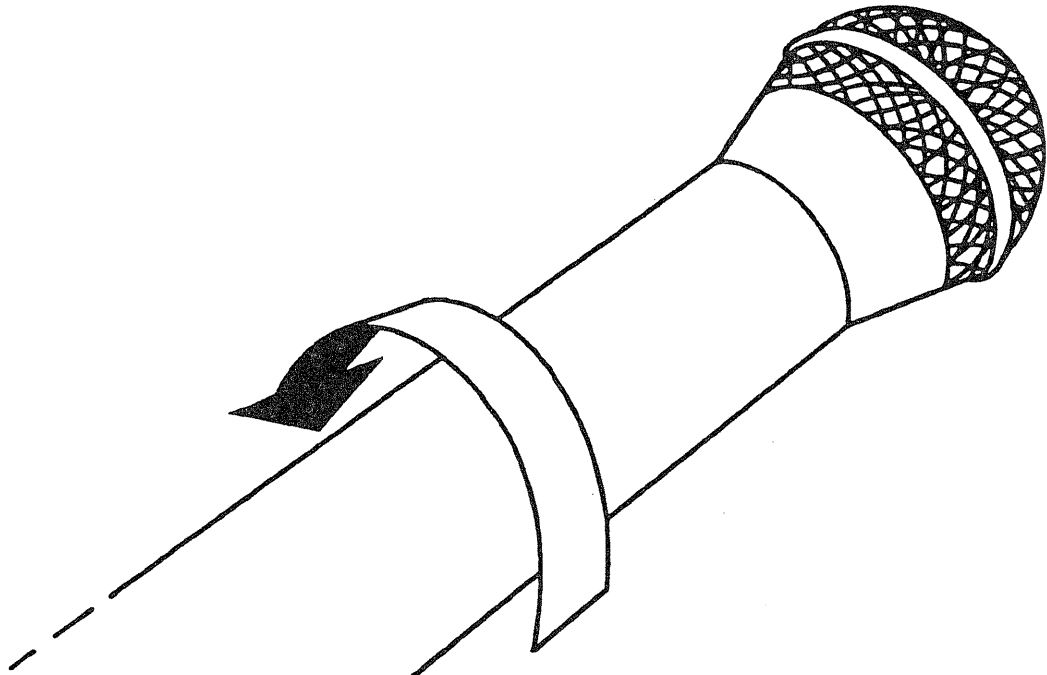

Figure 7B
HT-200 Handle Rotation

EQUIPMENT SET-UP

UNPACKING

Unpack your Wireless Microphone system. If there is any damage or shortage, refer to the "Warranty Service Information" section in this manual.

TRANSMITTER BATTERY INSTALLATION

BATTERY INFORMATION

NOTE: Make sure the power switch is in the "OFF" position when changing or installing new batteries.

For maximum uninterrupted service it is suggested that a new 9 volt alkaline battery (Mallory MN 1604 or equivalent) be installed prior to use. Operation on a heavy duty 8.4 volt nickel-cadmium battery is also permissible. For more information, see Battery Information section.

WT-55

Slide the battery access cover off and insert the battery terminals against the spring contacts, making sure the proper polarity is observed.

DO NOT apply pressure directly to the center of the battery cover when installing the cover.

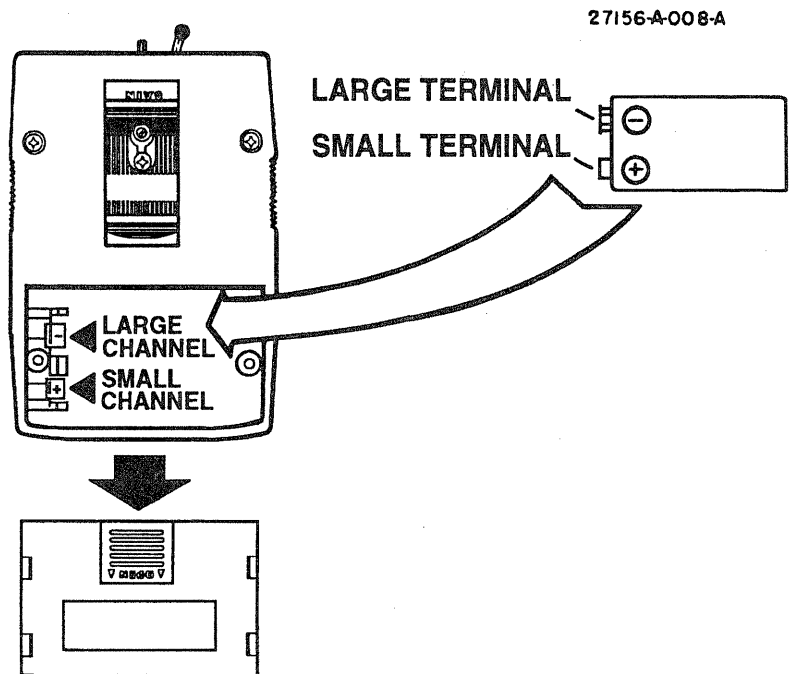

Figure 8
Battery Installation
WT-55 Belt Transmitter

ALL HT-200 SERIES MODELS

Battery Installation: Insure that the power switch is in the "OFF" position. To access the battery compartment, turn the handle of the microphone counter-clockwise (See Figure 3) and slide the handle down to expose the battery compartment.

The handle will "lock" into place, allowing convenient battery compartment access (See Figure 4).

The battery can be inserted in only one direction in order to prevent incorrect battery insertion.

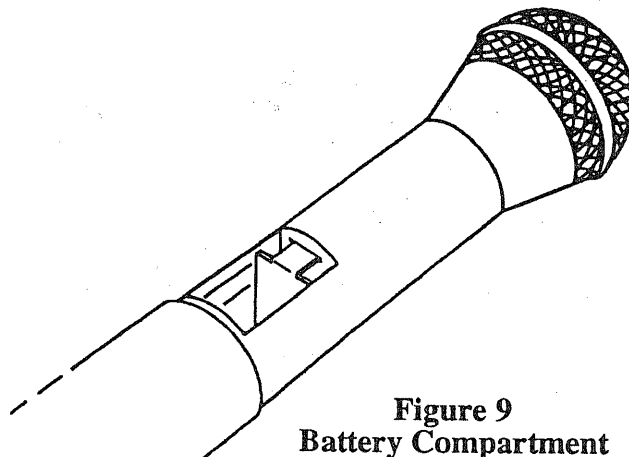

Figure 9
Battery Compartment

TRANSMITTER BATTERY CHECK

WT-55

On the top of the WT-55 is an LED and push button labeled Battery Test. This is the battery test switch and indicator LED. When the power switch is placed in the "ON" position and the test button is pushed the LED should light. If it does not light, replace the battery. The LED will fail to light when the voltage drops below 7.25 volts. At that time an average of 1 hour is left on the batter

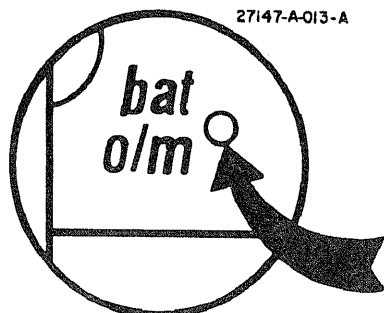

Figure 10
Low Battery/Indicator
WT-55

HT-100

Set the power switch to the "ON" position. Note that the battery LED, located on the bottom of the microphone, should flash one time for a good battery. A low power battery will cause the LED to be illuminated continuously and a bad or unusable battery will not cause any illumination at all. Set the power switch to the "OFF" position.

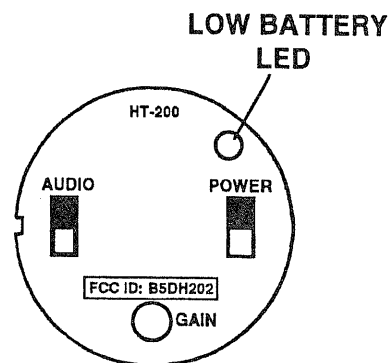

Figure 11
Low Battery LED - HT-100

TRANSMITTER MICROPHONE

WT-55

Plug the microphone you will be using into the microphone jack. If the microphone brand that you are using is other than Telex, refer to the wiring chart towards the end of the manual for interface information.

HT-200

The HT-200 Series comes in several models. All of these will work well with the FMR-70 receiver.

COMPANDOR IN/OUT

NOTE: The Compandor IN/OUT of the transmitter must match the Compandor of the receiver. The FMR-70 always has the compandor IN. Any transmitter used must also be companded.

WT-55

The WT-55 always operates with the compandor IN. Therefore your FMR-70 and WT-55 System is already matched.

HT-200

The HT-200 always operates with the compandor "IN", therefore, your FMR-70 and HT-200 System is already matched.

FMR-70 POWER CONNECTION

Locate the FMR-70 on a level surface with the rear of the unit facing you.

Connect the supplied AC power adaptor to an AC outlet supplying 105 to 125 volts AC, 60 Hz. The 220 volt export mode should connect to an AC outlet supplying 210-240 VAC, 50-60 HZ.

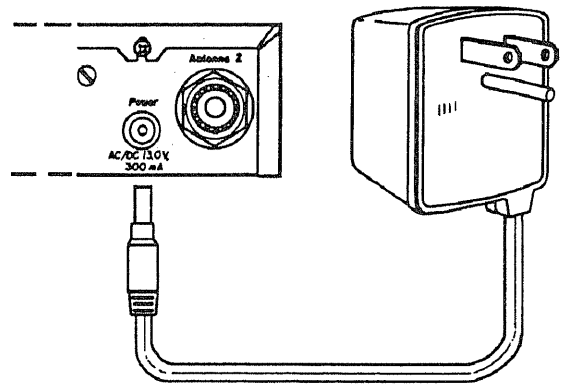

Figure 12
Power Connection

ANTENNA INFORMATION

FMR-70 Antenna Connection

The FMR-70 is supplied with two 1/4-wave vertical antennas. Attach the 1/4-wave antennas to the antenna input receptacle on the rear of the FMR-70 using the supplied connectors.

NOTE: If your FMR-70 receiver is to be located in a shielded rack mount enclosure or other poor RF location, you must use the 5/8-wave gain antennas and coax assemblies, Order No. 63900-000 (Specify frequency with order)

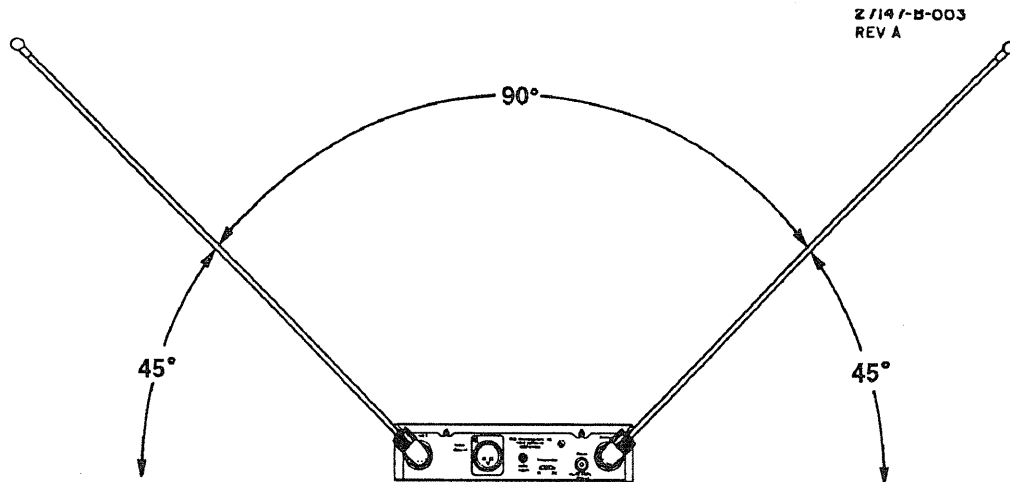

NOTE: THE ABOVE CONFIGURATION IS PROPER ANTENNA ALIGNMENT FOR THE FMR-100 RECEIVER. ANY OTHER ALIGNMENT OF THE ANTENNAS IS NOT ACCEPTABLE AND WILL AFFECT RECEPTION.

Figure 13
Proper Antenna Connection and Alignment

WT-55 ANTENNA PLACEMENT

Proper antenna placement probably has the biggest effect on your TELEX Wireless System's overall performance. The following suggestions will result in optimum performance.

Proper placement of the WT-55 transmitter can be critical. The trailing antenna should "dangle" freely. "Wadding" the antenna up and placing the WT-55 in a pocket, etc., will reduce system distance.

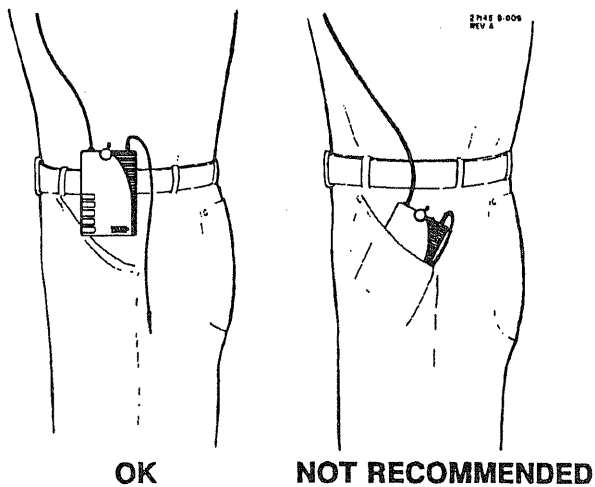

Figure 14
WT-55 Antenna Dressing

HT-200 ANTENNA

The antenna for the HT-200 is located inside the microphone handle. The antenna is efficient and is omnidirectional.

SYSTEM CONFIGURATION

Keep the distance between the transmitter and the FMR-70 antennas as short as possible. The greater the distance, the weaker the signal.

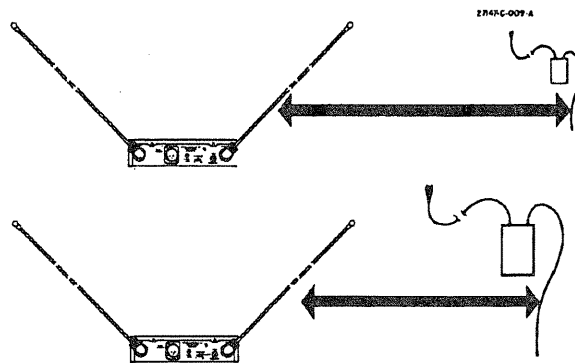

Figure 15
Distance Between Transmitter and Receiver

Make sure the "signal path" between the transmitter and the FMR-70 antennas is unobstructed. You should always be able to visibly locate the antenna at all times.

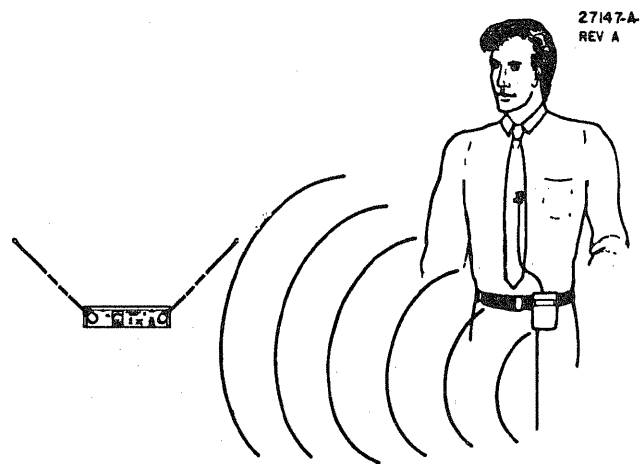

Figure 16
Keeping Site Clear to Antenna

Attempting to operate the wireless system through or around walls, ceilings, metal objects, etc. will reduce system range and performance

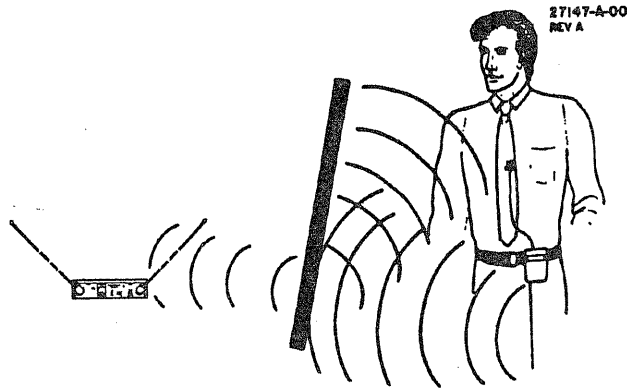

Figure 17
Operating Through Obstructions

DO NOT - Mount the receiver on, or next to, metal such as beams, walls with metal studs, equipment racks, etc. This will "detune" the receiving antenna which can result in noise or loss of RF signal at the FMR-70.

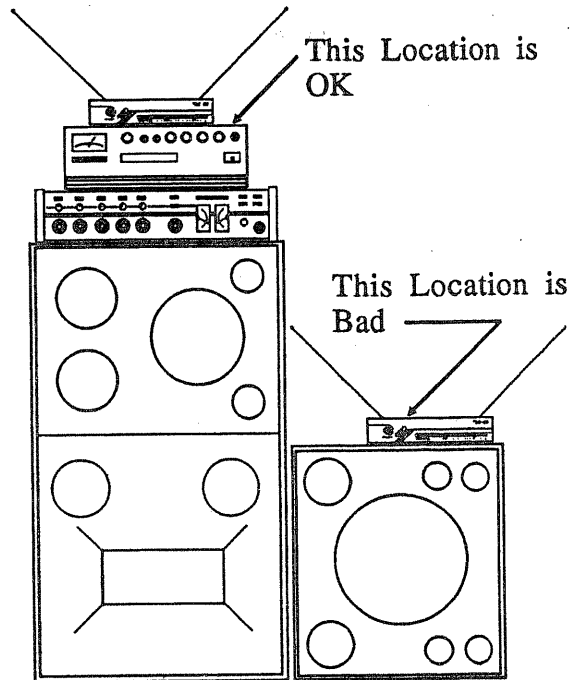

Figure 18
Receiver/Antenna Placement

INCREASING/IMPROVING RECEPTION AND RANGE

Keeping the distance from the transmitter and receiver as short, and unobstructed as possible will produce the most reliable performance.

The FMR-70 is supplied with two 1/4-wave antennas. This should provide satisfactory system performance in most applications. System range can be enhanced by using 5/8-wave antennas. A 5/8-wave antenna and a coax cable are required to remote the antenna. Two antenna's are required for best reception.

NOTE: When rack mounting the FMR-70 use two 5/8 wave antennas and remote the antennas. Refer to Figure 20.

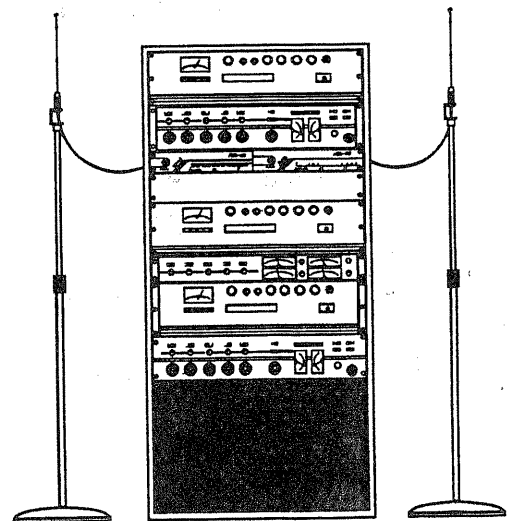

Figure 19
Remoting Antenna

To reduce the number of antennas required when operating more than one FMR-70 system in a given location, the Telex AD-200 amplified antenna splitter (See Accessory Section for Order No.) may be used. See Figure 20, below.

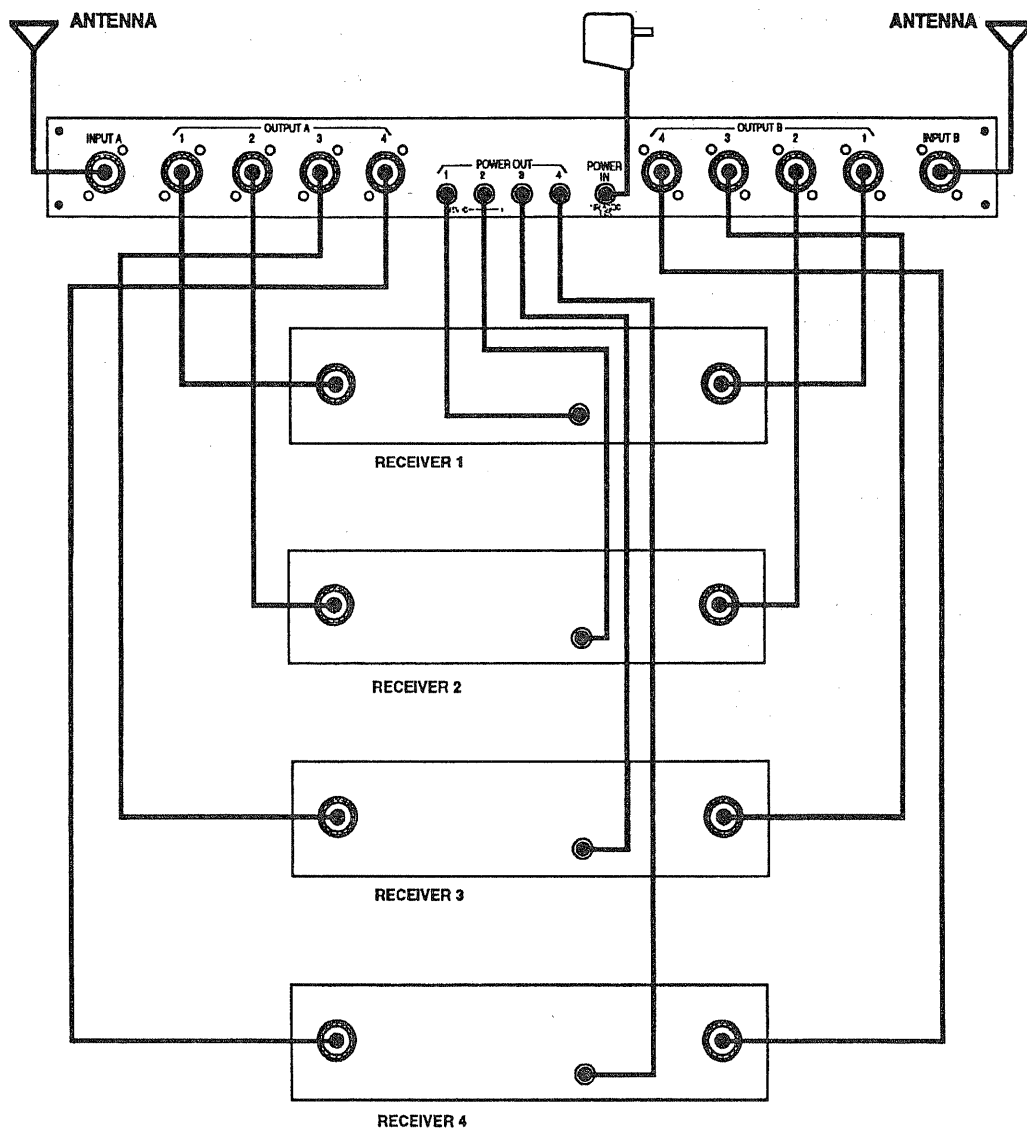

Figure 20
AD-200 Antenna Splitter

RECEIVER CONNECTION TO SOUND SYSTEM

The FMR-70 has been shipped with the output set to an output level similar to that of a wired low impedance microphone.

Connect the FMR-70 to your equipment:

- Insert the female end of the 3 pin "XLR" microphone cable into the Audio Output receptacle on the rear of the FMR-70.
- Insert the male end of the 3 pin "XLR" microphone cable into the "MIC LEVEL" input to your Mixer/Amplifier.
- For audio output adjust see Audio Adjustment in Setting System Gain Level

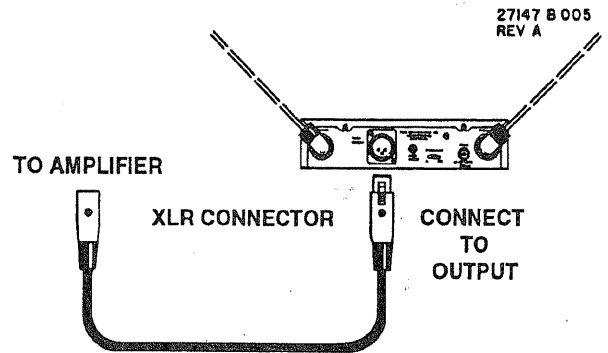

Figure 21
Connection to Mixer/Amplifier

SYSTEM TURN ON

INTRODUCTION

If you have followed the instructions up to this point you should now be ready to turn both the transmitter and the receiver "ON" and set optimum signal gain settings on each unit.

FMR-70 RECEIVER

Press the power switch on the FMR-70 receiver to the "ON" position. One of the Diversity LED's will illuminate indicating power on.

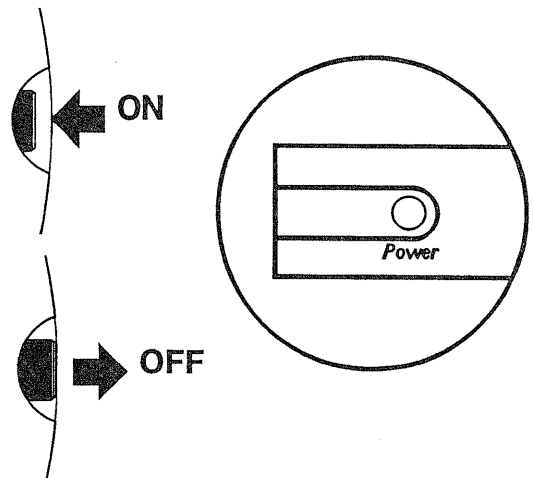

Figure 22
Power ON/OFF Switch

WT-55 BELT TRANSMITTER

Turn your transmitter power "ON". This is accomplished by placing the power on switch to "ON"

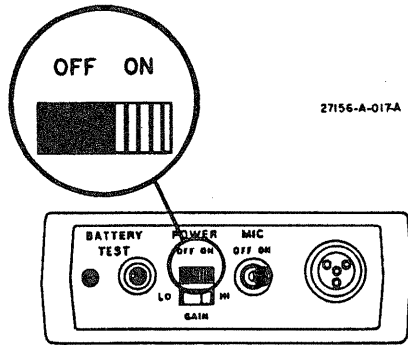

Figure 23
Power ON Switch

NOTE: For the HT-200, when the unit is turned on, the Low Battery LED will flash on briefly with fresh batteries installed. It will stay on continuously with a low battery and will not illuminate at all with a bad or unusable battery. The battery of the WT-55 will need to be tested by pushing the battery test button. The LED will light with good batteries installed.

HT-100 MICROPHONE

Set the HT-200 Power Switch to the "ON" position.

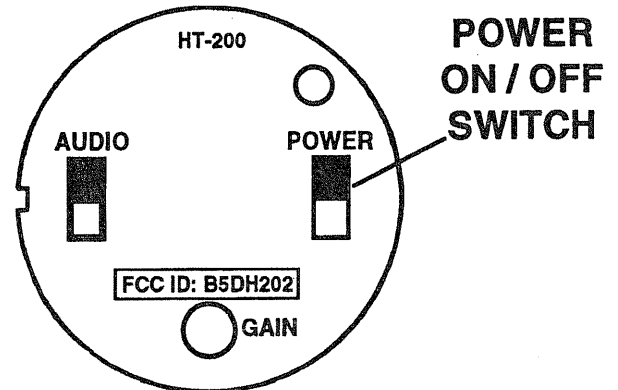

Figure 24
Power ON/OFF switch - HT-200

SETTING SYSTEM GAIN LEVELS

WT-55 AND HT-100 SOUND PRESSURE LEVEL (SPL)

Normal (SPL) Setting: The "Audio Gain" potentiometer on your transmitter has been factory set to provide readings on the FMR-70 four segment bar graph in the -20 /-8 area for normal vocal application. Readings in this area of the meter give highest dynamic range and no overload. See Figure.26.

High Level Setting: If your application is in a high SPL (Sound Pressure Level) area such as singing or instrumentation, the factory gain setting is probably too high. This will result in overloading your receiver, which will result in distortion.

Low Level Setting: If your application is low level, such as a very soft spoken individual or a situation where the handheld transmitter is not going to be "close talked", the factory gain setting may be too low and could result in poor overall signal-to-noise ratio.

To correct either a too high, or too low condition, simply use the gain adjustment on your transmitter (either the Hi/Lo Switch or the adjustment potentiometer for fine tuning) and adjust the Microphone Gain Control so that average audio causes the meter to indicate in the left (-20 and -8) area of your meter. An occasional overshoot into the 0 or +2 area is allowable.

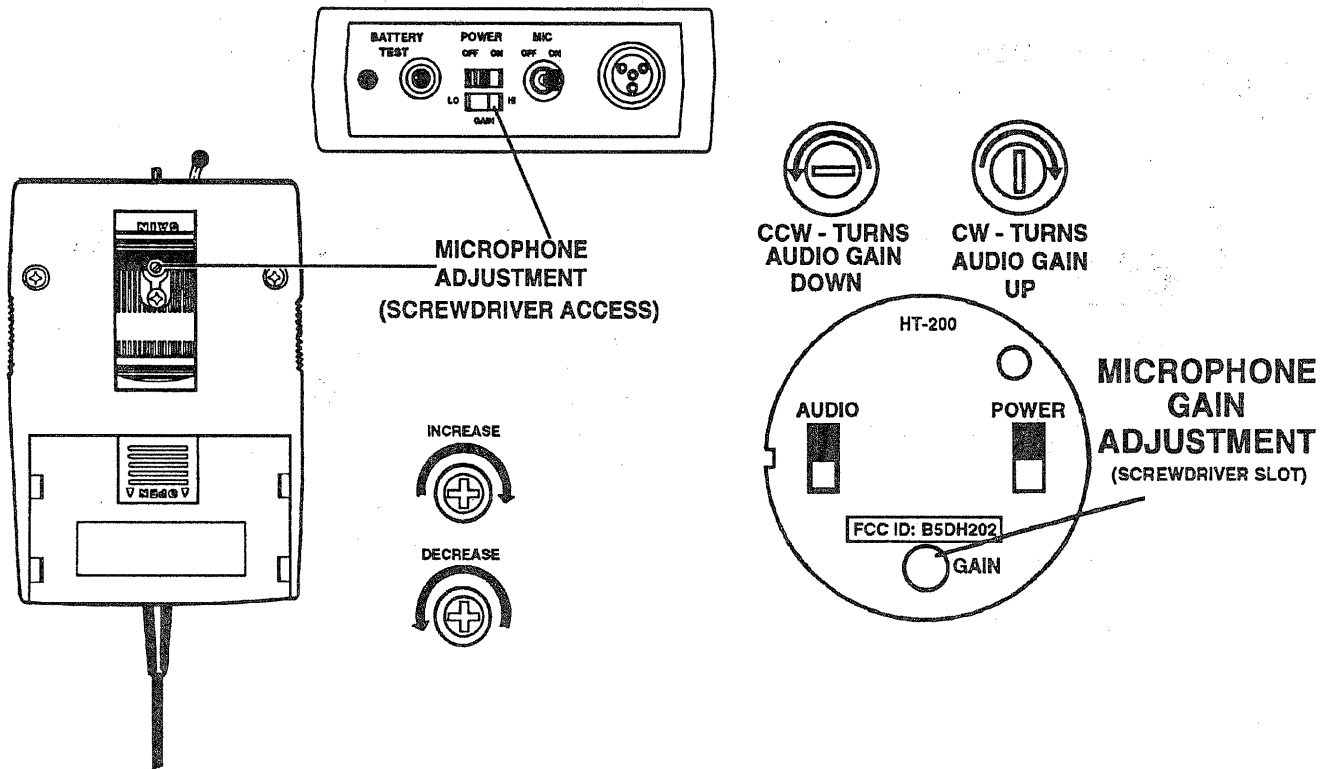

NORMAL LEVEL

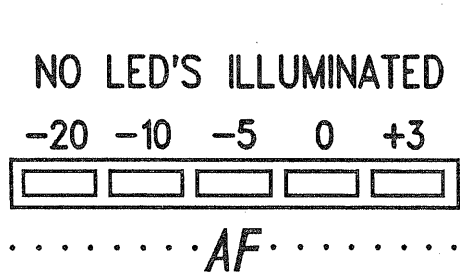
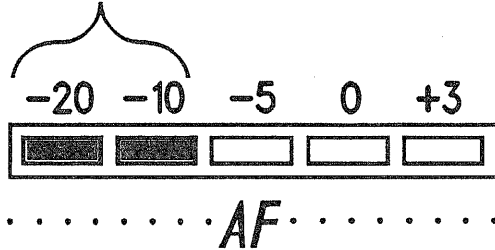

TOO LOW

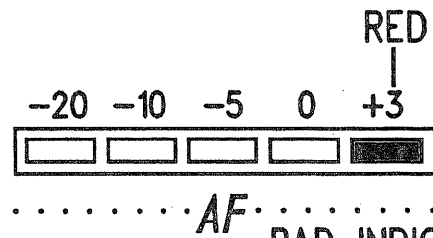

BAD INDICATION (DISTORTION)

TOO HIGH

Figure 25
Adjusting Microphone Gain

RECEIVER AUDIO ADJUST

Now that you have properly set the transmitter gain setting you are now ready to set the receiver output level. The purpose of this control is to give the ability to provide an audio output level from the Telex Wireless System that is similar to that of a wired microphone.

The Audio Adjust (screwdriver adjustable) is adjusted while talking into the transmitter microphone. Turn the adjustment screw to achieve the desired output level.

27156-A-020-A

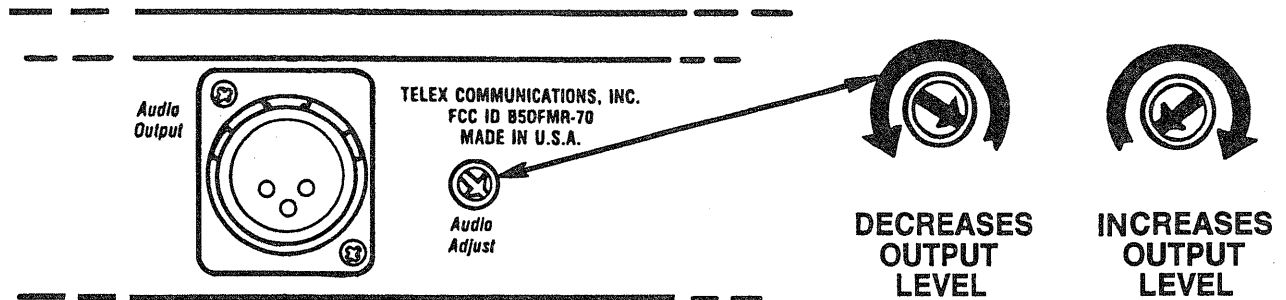

Figure 26
Audio Adjust Control

NOTE: DO NOT USE WITH PHANTOM POWER SYSTEMS. . . NOT TRANSFORMER ISOLATED.

SYSTEM WALK-THRU

GENERAL

Now that you have successfully "set up" your Telex Wireless System and turned on your sound equipment (amplifier/mixer, etc.), you are ready to test the overall performance by "walking" the transmitter through the areas in which you will be using it.

CARRIER INDICATION

Under normal conditions the Tx on LED indicator will be on at all times when the transmitter is on.

"Weak Signal" conditions will result in no or intermittent indication with the potential of actually "hearing" this in the sound system.

The "system walk-thru" can detect RF problems of weak signal strength caused by the following:

- Poor antenna location
- RF "Trouble Spots"
- Operating distance beyond system capability
- Old or used transmitter batteries

AUDIO FEEDBACK

The system walk-thru can also uncover locations in the performing areas which are prone to audio feedback (usually sounds like a "squeal" or a "howl"). Feedback can be a problem for any microphone - whether wired or wireless. To eliminate feedback, observe placement of the microphone and any nearby loudspeakers.

In 99% of all instances you will set up your Telex Wireless System, walk it through and achieve error-free performance. If in the rare instances your Telex System does not "pass" during your walk-thru evaluation, refer to the next section, which deals with System Troubleshooting.

TROUBLESHOOTING

Reread the sections of this manual to make sure you have completed system set-up properly.

If you are unable to solve the problem, contact the dealer you purchased the system from for assistance.

PROBLEM	SOLUTION
DISTORTION - System's audio quality seems distorted at medium to high input levels.	Reduce audio gain on transmitter by adjusting the gain control as suggested on page 20.
HISS - System seems to produce a "hiss" which is undesirable.	Check the gain setting on the transmitter as indicated on page 20.
DROPOUTS - When moving around the area in which you will be using the system there seem to be locations where the signal "swooshes" or completely disappears.	Make sure the receiver antenna is connected and fully extended. Follow the location suggestions in the manual. Change the location of the receiver antenna or avoid the bad area with the transmitter. Review antenna information on pages 14 thru 16.
INTERFERENCE - System picks up signals other than wireless transmitter.	Make sure the frequency of the transmitter matches the frequency of the receiver. Make sure the transmitter is turned on - this will usually eliminate the interference signal. If problems persist with the transmitter "ON" you will probably need to have your systems frequency changed to another channel.
REDUCED DISTANCE - System doesn't operate as far as it once did. System doesn't operate as well as you think it should.	Transmitter battery is possibly in need of replacement. Receiver antenna possibly not in correct place. Review antenna information on pages 14 thru 16.
BATTERIES DON'T LAST	If using "throw away" batteries make sure they are alkaline. If using nickel-cadmium batteries make sure they were fully charged prior to using them and fully drained when you are done before recharging them.
LOW OUTPUT - System produces a lower output level than other wired microphones in sound system.	Check the gain settings on the transmitter as indicated on page 20 and the audio adjustment on the receiver as shown on page 21.
FEEDBACK - Moving around performing area produces "squeal" or "howl" in various locations.	Reduce gain settings on wireless system and sound system. Professional equalization may be needed to cure this problem.

BATTERY INFORMATION

GENERAL

Improper battery selection, use, installation and care are the cause of numerous wireless microphone system failures.

ALKALINE BATTERIES

Alkaline batteries such as Mallory's DURACELL® or Eveready's ENERGIZER® provide the most reliable operation in wireless microphone transmitters. Low cost carbon zinc "bargain" batteries are lower cost but will not sufficiently operate the transmitter.

NICKEL-CADMIUM BATTERIES

Nickel-Cadmium batteries can save you money in the long run, as they can be recharged, but nickel-cadmium's can also cause disappointing wireless performance. If you want to use rechargeable nickel-cadmium batteries you must select a "heavy duty" nickel-cadmium. Conventional "9 volt size" such as GE® or Radio Shack® are only capable of providing 7.2 volts, which is not sufficient to power the Telex WT-55 and HT-200 transmitters.

Battery Type	Volts	Expected Life
Conventional "RAY-O-VAC" Carbon Zinc	9	Not Recommended for HT-100/10, 1 Hour for WT-55
Alkaline MN1604 or Equivalent	9	6 to 8 Hours
GE or Radio Shack Nickel-Cadmium Rechargeablearta	7.2	Does Not Work
Varta or Gould "Again and Again" Nicikel-Cadmium Rechargeable	8.4	1 1/2 to 2 Hours per charge

Table 1
Battery Information
For HT-200 and WT-55

ENERGIZER ® is a registered trademark of Union Carbide Corporation.
DURACELL® is a registered trademark of Duracell Inc.
GE® is a registered trademark of General Electric Company
Radio Shack® is a registered trademark of the Tandy Corp.

MICROPHONE WIRING CHART

LAVALIERS	MODEL NO.	PIN 1	PIN 2	PIN3
SONY	ECM 150	N/C	RED	SHLD
SONY	ECM 50	SHLD	WHITE	RED
SONY	ECM 77	SHLD	WHITE	RED
SONY	ECM 55	SHLD	WHITE	RED
SENNHEISER	MKE-2	SHLD	BLACK	RED
SENNHEISER	MKE-40	SHLD	BLUE	RED
TRAM	TR-50LX	SHLD	BLACK	RED
BEYER	MCE 5.9	OUTER SHLD	GREEN	INNER SHLD
CROWN	PZM	BLACK & SHLD	WHITE	RED
AUDIO TECHNICA	AT 831C	SHLD	YELLOW (2)	RED (2)
AUDIO TECHNICA	AT 803C	SHLD	YELLOW BLACK	WHITE/ RED
SHURE	SM83	SHLD	BLACK	RED
SHURE	SM10-A-HEADSET	BLACK SHLD	RED	N/C
ELECTRO VOICE	CO-90	SHLD	WHITE	RED
COUNTRYMAN	ISOMAX II	BLACK SHLD	WHITE	RED
FENDER	M-1	BLACK SHLD	WHITE	RED
AKG	CK67-3	N/C	SHLD	WHITE
SONY	ECM44	SHLD	WHITE	RED
+BIAS LAVALIER	3 WIRE	SHLD	AUDIO	BIAS
-BIAS LAVALIER	3 WIRE	BIAS	AUDIO	SHLD
+BIAS LAVALIER	2 WIRE	N/C	SHLD	AUDIO
-BIAS LAVALIER	2 WIRE	N/C	AUDIO	SHLD
PIN INFOMATION		GRND	AUDIO	BIAS

ACCESSORIES

Wall Mount Bracket - For vertical 5/8-wave antenna.

Order No. 63906-000

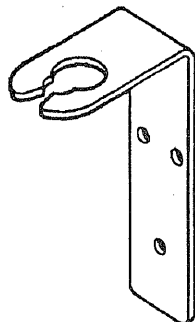

25' Coax Cable

Order No. 63901-000

EO-SING-A-007

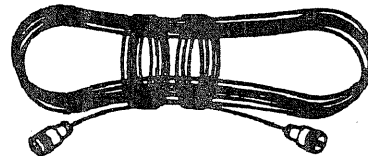

Microphone Stand Bracket Assembly - For mounting vertical 5/8-wave antennas on microphone stand.

Order No. 63907-000

EO-SING-A-008

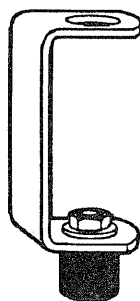

4' Coax Cable

Order No. 63901-001

AC Power Supply

120 Volt, 60 Hz - Order No. 730092000

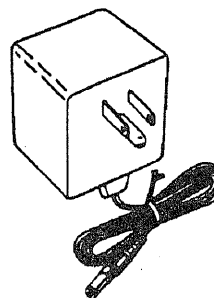

Replacement Tie Clips/Pin for WLM-50 Tie Clip Assembly

Horizontal - Order No. 63850-004

Vertical - Order No. 63850-005

Tie Pin - Order No. 63848-001

EO-SING-A-009

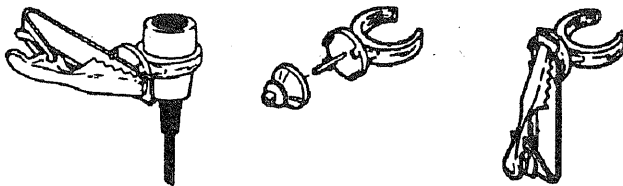

VHF Log Periodic Directional Antenna - 150-216 MHz only. Elements fold for compact storage. Comes complete with canvas carrying case.

Order No. 63910-000

EO-SING-A-011

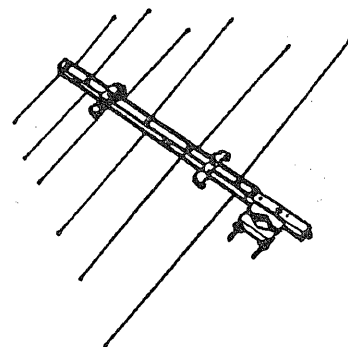

ACCESSORIES (Cont.)

Vertical 5/8-Wave Antenna - Screw apart for easy storing. Comes with 25 feet of coax.
150-176 MHz - Order No. 63900-000
176-216 MHz - Order No. 63900-001

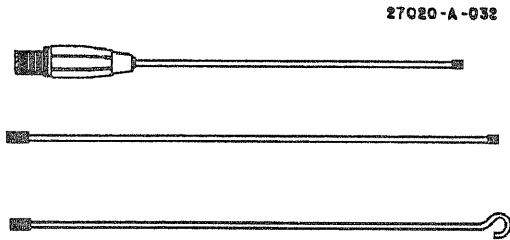

BC-2 Battery Charger - For charging nickel-cadmium battery used in HT-100.
Order No. 64267-000

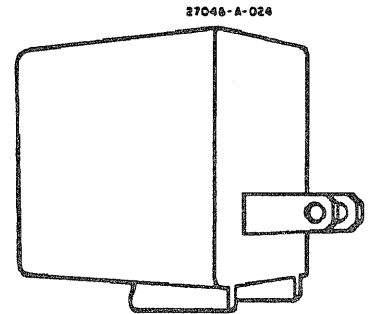

Batteries -
WT-55/HT-100 - Nickel-Cadmium 8.4 volt battery
Order No. 63912-000



AD-200 - Amplified broadband antenna splitter.
Order No. 71108000

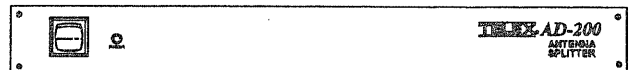

WARRANTY SERVICE INFORMATION

If your receiver or transmitter should need servicing under the warranty, please contact:

Warranty Service Department
TELEX COMMUNICATIONS, INC.
8601 East Cornhusker Highway,
P.O. Box 5579,
Lincoln, Nebraska 68505-5579 U.S.A.
Phone: (402) 467-5321 or 465-7021

All claims of defect or shortage should be sent to the above address. When returning items for service, you must provide date and proof of purchase, such as a copy of the sales receipt, to establish warranty. A letter should be included outlining all symptoms and claimed defects. Information on how the equipment was installed and used is very helpful. Please include your phone number and return address in case our service technicians need to contact you.

Units that have been modified cannot be accepted for repair.

Include all information requested by the Service Center. Then pack the unit as follows:

Check the unit to see that all parts and screws are in place. Then wrap it in heavy paper or put it in a plastic bag. If the original carton is not available, place the unit in a strong carton that is at least six inches bigger in all three dimensions than the unit. Fill the carton equally around the unit with resilient packing material (shredded paper, excelsior, etc.) Seal it with gummed paper tape, tie it with a strong cord, and ship it by prepaid express, United Parcel Service or insured parcel post to the Hy-Gain Service Center.

It is very important that the shipment be well-packed and fully insured. Damage claims must be settled between you and the carrier and this can delay repair and return of the unit to you.

Telex reserves the right to make changes in design and improvement on its product without assuming any obligation to install the same on any of its products previously manufactured. Further Telex reserves the right to ship new and/or improved products which are similar to the form, fit and function of products originally ordered.

FCC INFORMATION

The TELEX Model WT-55 and HT-200 Transmitters are Type Accepted under United States Federal Communication Commission Part 90 and 74. The FMR-70 Receiver has notification under Part 15 of the Federal Communication Commission. Licensing of TELEX equipment is the user's responsibility and licensability depends upon the user's classification, and frequency selected. TELEX strongly urges the user to contact the appropriate telecommunications authority before ordering and choosing frequencies.

PATENT INFORMATION

MANUFACTURED UNDER ONE
OR MORE OF THE FOLLOWING
U.S. PATENTS

U.S. PATENT NO. 4,293,955

U.S. PATENT NO. 5,029,238

OTHER PATENTS PENDING

TELEX®

TELEX COMMUNICATIONS, INC. • 9600 Aldrich Ave. So., Minneapolis, MN 55420 U.S.A.

PN 802534

16 JUNE 1995